



# MAGNIFYING GLASS COLLECTION

VOL.7



MAGNIFYING GLASS COLLECTION



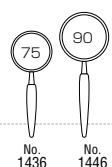

**High Quality White Glass Lens, Brass Frame, Gold Plated with Wooden Handle**

- No.1436 **2.5x** 75 m<sub>m</sub> (3")
- No.1446 **2.5x** 90 m<sub>m</sub> (3 1/2")
- inner box : 10pcs

WL

**Bifocal Hard Coating Plastic Lens, Gold Plated with Wooden Handle**

- No.1400 **1.8x & 3.5x** (Bifocal Lens)
- 110x145 m<sub>m</sub> (4 3/8" x 5 3/4")
- inner box : 10pcs



With Lens Cover

PL

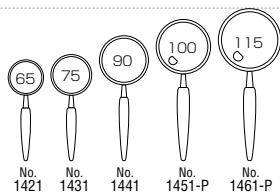

**High Quality White Glass Lens Brass Frame, Chrome Plated with Wooden Handle**

- No.1421 **3x** 65 m<sub>m</sub> (2 1/2") WL
- No.1431 **2.5x** 75 m<sub>m</sub> (3") WL
- No.1441 **2.5x** 90 m<sub>m</sub> (3 1/2") WL
- No.1451-P **2x & 4x** (Bifocal Lens) 100 m<sub>m</sub> (4") PL
- No.1461-P **1.8x & 4x** (Bifocal Lens) 115 m<sub>m</sub> (4 1/2") PL
- inner box : 10pcs

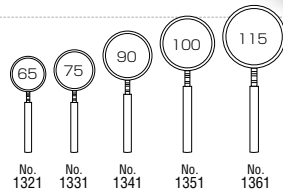

**Brass Frame, Chrome Plated with Wood Grain Plastic Handle**

- No.1321 **3x** 65 m<sub>m</sub> (2 1/2")
- No.1331 **2.5x** 75 m<sub>m</sub> (3")
- No.1341 **2.5x** 90 m<sub>m</sub> (3 1/2")
- No.1351 **2x** 100 m<sub>m</sub> (4")
- No.1361 **1.8x** 115 m<sub>m</sub> (4 1/2")
- inner box : 10pcs

GL

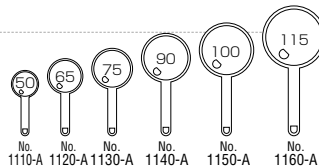

**Bifocal Hard Coating Plastic Lens, Silver Color Plastic Frame & Handle**

- No.1110-A **3x & 4.5x** (Bifocal Lens) 50 m<sub>m</sub> (2")
- No.1120-A **2.5x & 4x** (Bifocal Lens) 65 m<sub>m</sub> (2 1/2") Hook
- No.1130-A **2x & 4x** (Bifocal Lens) 75 m<sub>m</sub> (3") Hook
- No.1140-A **2x & 4x** (Bifocal Lens) 90 m<sub>m</sub> (3 1/2") Hook
- No.1150-A **2x & 4x** (Bifocal Lens) 100 m<sub>m</sub> (4") Hook
- No.1160-A **1.8x & 4x** (Bifocal Lens) 115 m<sub>m</sub> (4 1/2") Hook
- inner box : 10pcs

PL

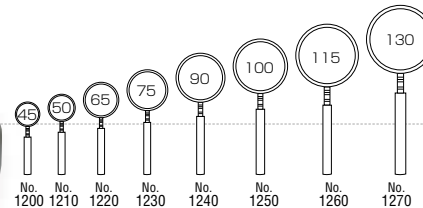

**Brass Frame, Chrome Plated with Black Plastic Handle**

- No.1200 **3.5x** 45 m<sub>m</sub> (1 3/4")
- No.1210 **3.5x** 50 m<sub>m</sub> (2")
- No.1220 **3x** 65 m<sub>m</sub> (2 1/2") Hook
- No.1230 **2.5x** 75 m<sub>m</sub> (3") Hook
- No.1240 **2.5x** 90 m<sub>m</sub> (3 1/2") Hook
- No.1250 **2x** 100 m<sub>m</sub> (4") Hook
- No.1260 **1.8x** 115 m<sub>m</sub> (4 1/2") Hook
- No.1270 **1.8x** 130 m<sub>m</sub> (5")
- inner box : 12pcs

GL

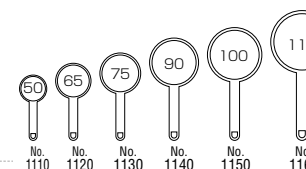

**Black Plastic Frame & Handle**

- No.1110 **3x** 50 m<sub>m</sub> (2")
- No.1120 **2.5x** 65 m<sub>m</sub> (2 1/2") Hook
- No.1130 **2x** 75 m<sub>m</sub> (3") Hook
- No.1140 **2x** 90 m<sub>m</sub> (3 1/2") Hook
- No.1150 **2x** 100 m<sub>m</sub> (4") Hook
- No.1160 **1.8x** 115 m<sub>m</sub> (4 1/2") Hook
- inner box : 10pcs

GL

Hanging type

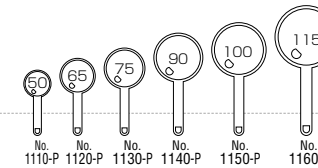

**Bifocal Hard Coating Plastic Lens, Plastic Frame & Handle**

- No.1110-P **3x & 4.5x** (Bifocal Lens) 50 m<sub>m</sub> (2")
- No.1120-P **2.5x & 4x** (Bifocal Lens) 65 m<sub>m</sub> (2 1/2") Hook
- No.1130-P **2x & 4x** (Bifocal Lens) 75 m<sub>m</sub> (3") Hook
- No.1140-P **2x & 4x** (Bifocal Lens) 90 m<sub>m</sub> (3 1/2") Hook
- No.1150-P **2x & 4x** (Bifocal Lens) 100 m<sub>m</sub> (4") Hook
- No.1160-P **1.8x & 4x** (Bifocal Lens) 115 m<sub>m</sub> (4 1/2") Hook
- inner box : 10pcs

PL



**Bifocal Hard Coating Plastic Lens, Brass Frame Chrome Plated with Black Plastic Handle**

- No.1210-P **3x & 4.5x** (Bifocal Lens) 50 m<sub>m</sub> (2")
- No.1220-P **2.5x & 4x** (Bifocal Lens) 65 m<sub>m</sub> (2 1/2") Hook
- No.1230-P **2x & 4x** (Bifocal Lens) 75 m<sub>m</sub> (3") Hook
- No.1240-P **2x & 4x** (Bifocal Lens) 90 m<sub>m</sub> (3 1/2") Hook
- No.1250-P **2x & 4x** (Bifocal Lens) 100 m<sub>m</sub> (4") Hook
- No.1260-P **1.8x & 4x** (Bifocal Lens) 115 m<sub>m</sub> (4 1/2") Hook
- inner box : 12pcs

PL

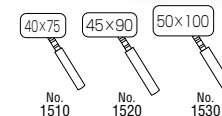
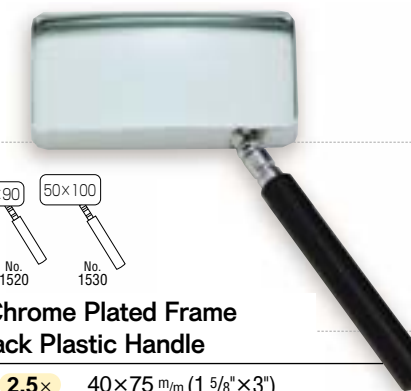

**Brass Chrome Plated Frame with Black Plastic Handle**

- No.1510 **2.5x** 40x75 m<sub>m</sub> (1 5/8" x 3")
- No.1520 **2.5x** 45x90 m<sub>m</sub> (1 3/4" x 3 1/2")
- No.1530 **2x** 50x100 m<sub>m</sub> (2" x 4")
- inner box : 12pcs

GL

GL : glass lens type    WL : white lens type    PL : plastic lens type    Hook : A strap is available for suspending.

To order the hanging type, add an F in the end of the product number when ordering.

READING GLASS · REDUCING TYPE

DISPLAY SET

ASPHERICAL MAGNIFIER



Magnifier with an aspheric clear lens  
The magnification of the normal 90 mm type is approximately ×2.  
The magnification using the aspheric clear lens is ×3.5.  
The distance for best viewing results is 6 to 7 cm from the object to the lens.



The handle is covered with real leather.

With Lens Cover

With Pouch

No.AS-14 **3.5×** 90 m/m (3 1/2")  
● Hard Coating Plastic Lens **ASPHERICAL** **PL**  
● inner box : 10pcs  
● With Pouch

No.AS-24 **3.5×** 90 m/m (3 1/2")  
● Hard Coating Plastic Lens **ASPHERICAL** **PL**  
● inner box : 10pcs  
● Supplied with a synthetic leather lens container

FANCY MAGNIFIER



No.PF-45 **2.5×** 45 m/m (1 1/2")  
● inner box : 20pcs  
● Color : black · blue · red · green · light green **PL**

No.LF-45 **3.5×** 45 m/m (1 5/8")  
● inner box : 20pcs  
● Color : black · blue · red · green · yellow **GL**

No.LF-50  
**3.5×** 50 m/m (2")  
● inner box : 20pcs **GL**

REDUCING TYPE



No.220 **3.5×** 36 m/m (1 1/2")  
● inner box : 50pcs **GL**

No.132 **3.5×** 40 m/m (1 5/8")  
● inner box : 12pcs **GL**

No.1550-P  
**2× & 4× (Bifocal Lens)** 75 m/m (3")  
● inner box : 20pcs **PL**

Many applications including global view of artwork, picture composition, large-sized printed material, quilts work preparation. Brass Frame, Chrome Plated with Wooden Handle.  
Reducing type (Concave lens)  
No.CC-90 **0.4×** 90 m/m (3 1/2")  
● inner box : 10pcs **GL**



No.2000 28pcs. Set. inner box  
No.1210 **3.5×** 50 m/m (2") 6  
No.1220 **3×** 65 m/m (2 1/2") 6  
No.1230 **2.5×** 75 m/m (3") 6  
No.1240 **2.5×** 90 m/m (3 1/2") 4  
No.1250 **2×** 100 m/m (4") 4  
No.1260 **1.8×** 115 m/m (4 1/2") 2



No.ST-15 15pcs. Set. inner box  
No.1110-A **3× & 4.5× (Bifocal Lens)** 50 m/m (2") 2  
No.1120-A **2.5× & 4× (Bifocal Lens)** 65 m/m (2 1/2") 3  
No.1130-A **2× & 4× (Bifocal Lens)** 75 m/m (3") 3  
No.1140-A **2× & 4× (Bifocal Lens)** 90 m/m (3 1/2") 3  
No.1150-A **2× & 4× (Bifocal Lens)** 100 m/m (4") 2  
No.1160-A **1.8× & 4× (Bifocal Lens)** 115 m/m (4 1/2") 2



No.ST-17  
MAGNIFIER 17pcs. Set. inner box  
No.1110-P **3× & 4.5× (Bifocal Lens)** 50 m/m (2") 1  
No.1120-P **2.5× & 4× (Bifocal Lens)** 65 m/m (2 1/2") 1  
No.1130-P **2× & 4× (Bifocal Lens)** 75 m/m (3") 1  
No.1140-P **2× & 4× (Bifocal Lens)** 90 m/m (3 1/2") 1  
No.1150-P **2× & 4× (Bifocal Lens)** 100 m/m (4") 1  
No.1160-P **1.8× & 4× (Bifocal Lens)** 115 m/m (4 1/2") 1



No.ST-22  
MAGNIFIER 22pcs. Set. inner box  
No.1110 **3×** 50 m/m (2") 2  
No.1120 **2.5×** 65 m/m (2 1/2") 2  
No.1130 **2×** 75 m/m (3") 2  
No.1140 **2×** 90 m/m (3 1/2") 2  
No.1150 **2×** 100 m/m (4") 1  
No.1160 **1.8×** 115 m/m (4 1/2") 1  
No.3150 **3.5×** 45 m/m (1 3/4") 2  
No.3180 **2.5×** 45×65 m/m (1 3/4"×2 1/2") 2  
No.L-120 **3.5×** 50 m/m (2") 2  
No.HL-60 **3×** 60 m/m (2 3/8") 2  
No.1885 **4×** 50 m/m (2") 2  
No.1820 **3.5×** 60 m/m (2 3/8") 2

No.L-160 **2.5×** 75 m/m (3") 1  
No.L-170 **2.5×** 90 m/m (3 1/2") 1  
No.L-180P **2× & 4× (Bifocal Lens)** 100 m/m (4") 1  
No.1850 **2× & 3× & 6×** 80 m/m (3 1/8") 1  
No.3151K **3.5×** 45 m/m (1 3/4") 1  
No.1820 **3.5×** 60 m/m (2 3/8") 1  
No.7050 **10×** 20 m/m (3/4") 1  
No.7550 **6×** 25 m/m (1") 1  
No.SL-10 **10×** 28 m/m (1 1/8") 1  
No.3122 **3×** 65 m/m (2 1/2") 1  
No.7960 **4× & 4×** 36 m/m (1 1/2") 1



No.6000 8pcs. Set. inner box  
No.1210 **3.5×** 50 m/m (2") 2  
No.1220 **3×** 65 m/m (2 1/2") 2  
No.1230 **2.5×** 75 m/m (3") 2  
No.1240 **2.5×** 90 m/m (3 1/2") 1  
No.1250 **2×** 100 m/m (4") 1



No.3800 7pcs. Set. inner box  
No.1200 **3.5×** 45 m/m (1 3/4") 2  
No.1210 **3.5×** 50 m/m (2") 2  
No.1220 **3×** 65 m/m (2 1/2") 2  
No.1230 **2.5×** 75 m/m (3") 1

**GL** : glass lens type    **WL** : white lens type    **PL** : plastic lens type    **Hook** : A strap is available for suspending.

To order the hanging type, add an F in the end of the product number when ordering.

LIGHT MAGNIFIER

POCKET MAGNIFIER



No.L-160 **2.5x** 75 mm (3")   
 No.L-170 **2.5x** 90 mm (3 1/2")   
 ● inner box : 10pcs  
 ● AA size battery x2 required

No.L-180P  
**2x & 4x (Bifocal Lens)** 100 mm (4")  
 ● inner box : 10pcs   
 ● AA size battery x2 required

Folding type



HANDY LIGHT MAGNIFIER

No.HL-60 **3x** 60 mm (2 3/8")  
 ● inner box : 10pcs   
 ● AAA size battery x2 required

For carrying in a pocket or handbag



No.3135 **3.5x** 50 mm (2")  
 ● inner box : 10pcs   
 ● Folding type in leather clad case  
 ● Color : black·brown·wine red



No.3130 **3x** 40x50 mm (1 5/8" x 2")  
 ● inner box : 12pcs   
 ● Folding type in leather clad case  
 ● Color : black·brown·wine red



No.3140 **3x** 50x60 mm (2" x 2 3/8")  
 ● inner box : 12pcs   
 ● Folding type in leather clad case  
 ● Color : black·brown·wine red



No.3151K **3.5x** 45 mm (1 3/4")  
 ● inner box : 10pcs   
 ● Folding type in leather clad case  
 ● Color : black·brown·wine red



No.M-50 **2.5x** 45x90 mm (1 3/4" x 3 1/2")  
 ● C size battery x2 required



No.M-320 **2x** 80 mm (3 1/8")  
 ● C size battery x2 required



No.M-322 **2.5x** 80 mm (3 1/8")  
 ● C size battery x2 required



No.M-323 **3.5x** 80 mm (3 1/8")  
 ● C size battery x2 required



No.3123 **3.5x** 45 mm (1 3/4")  
 ● inner box : 10pcs   
 ● Folding type in leather clad case  
 ● Color : red·camel·black



No.3125 **3x** 65 mm (2 1/2")  
 ● inner box : 12pcs   
 ● Folding type in leather clad case  
 ● Color : red·camel·black



No.3100 **3x** 60 mm (2 3/8")  
 ● inner box : 10pcs



No.3180 **2.5x** 45x65 mm (1 3/4" x 2 1/2")  
 ● inner box : 12pcs



No.3190N **2.5x** 57x75 mm (2 1/4" x 3")  
 ● inner box : 10pcs



No.3122 **3x** 65 mm (2 1/2")  
 ● inner box : 12pcs   
 ● Color : black·brown·red



No.3120 **3.5x** 45 mm (1 3/4")  
 ● inner box : 12pcs   
 ● Color : black·brown



No.3155 **3.5x** 50 mm (2")  
 ● inner box : 10pcs   
 ● Color : black·brown·red



No.M-350 **5x** 45 mm (1 3/4")  
 ● inner box : 12pcs   
 ● C size battery x2 required



No.M-335 **3.5x** 45 mm (1 3/4")  
 ● inner box : 12pcs   
 ● C size battery x2 required



No.M-170 **7x** 30 mm (1 1/4")  
 ● inner box : 12pcs   
 ● C size battery x2 required



No.M-100 **10x** 30 mm (1 1/4")  
 ● inner box : 12pcs   
 ● C size battery x2 required



No.3150 **3.5x** 45 mm (1 3/4")  
 ● inner box : 12pcs   
 ● Color : black·brown·red



No.3160 **3.5x** 45 mm (1 3/4")  
 ● inner box : 12pcs



No.3175-P **3x** 40x50 mm (1 5/8" x 2")  
 ● inner box : 12pcs   
 ● Color : black·brown·red



No.3170-P **3x** 40x50 mm (1 5/8" x 2")  
 ● inner box : 12pcs   
 ● Color : black·brown·red



No.M-88 **5x** 50 mm (2")  
 ● inner box : 6pcs   
 ● D size battery x2 required



No.L-120 **3.5x** 50 mm (2")  
 ● inner box : 12pcs   
 ● AA size battery x2 required



No.L-150 **3x** 65 mm (2 1/2")  
 ● inner box : 12pcs   
 ● AA size battery x2 required

with LED Light



LED, providing bright clear light so no bulb replacement problems.

No.HL-90 **2x** 55x90 mm (2 1/8" x 3 1/2")  
 ● inner box : 10pcs   
 ● Supplied with 3-LR44 batteries  
 ● Supplied with a case  
 ● Fresnel lens

: glass lens type : white lens type : plastic lens type : A strap is available for suspending.

To order the hanging type, add an F in the end of the product number when ordering.

DESK LOUPE · PAPER WEIGHT MAGNIFIER · BAR MAGNIFIER

MAGNIFYING SHEET · TWEEZER MAGNIFIER

**DESK LOUPE** You can obtain the correct distance for viewing by just placing the DESK MAGNIFIER on the object. Can also be used as a paperweight.

**MAGNIFYING SHEET (Fresnel Lens)**



No.1850 **2× & 3× & 6×** 80 mm (3 1/8")  
 ● inner box : 10pcs  
 [Registration of this model has been filed]



3× WL 2× PL  
 The combination with the upper and lower magnifiers provides 3 different magnifications.



No.1860 **3.5×** 50 mm (2")  
 ● inner box : 10pcs  
 ● For precision work



Magnifying paper materials, providing increased light. Easy to carry.

No.1885 **4×** 50 mm (2")  
 ● inner box : 10pcs



No.1810 **4×** 50 mm (2")

No.1820 **3.5×** 60 mm (2 3/8") Hook

No.1830 **3×** 75 mm (3") Hook

● inner box : 10pcs



No.SL-5 **4.5×** 30 mm (1 1/4")

● inner box : 10pcs  
 ● Supplied with a scale in 1 mm steps  
 ● Convenient for viewing photographic negatives



No.020 **2×**  
 215×280 mm (8 1/2"×11")  
 ● inner box : 100pcs  
 ● Thickness : 0.5mm



No.022 **1.8×**  
 165×230 mm (6 1/2"×9")  
 ● inner box : 100pcs  
 ● Thickness : 0.5mm



No.130 **3.5×**  
 38×140 mm (1 1/2"×5 1/2")  
 ● inner box : 200pcs  
 ● Book mark type  
 ● Ribbon color : red · purple  
 ● Thickness : 0.4mm

No.TL-1 **3.5× & 6× (Bifocal Lens)**  
 185×60 mm (7 1/4"×2 3/8")  
 ● inner box : 20pcs  
 ● With Case  
 ● 12cm Scale  
 ● Made of acrylic  
 ● Thickness : 1.3mm

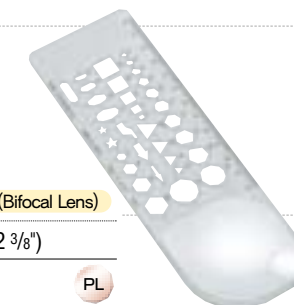

No.100 **3.5×**  
 47×100 mm (1 7/8"×4")  
 ● inner box : 100pcs  
 ● 8cm Scale, Pullout type  
 ● Color : brown · blue  
 ● Thickness : 0.4mm



**PAPER WEIGHT MAGNIFIER** You can obtain the correct distance for viewing by just placing the PAPER WEIGHT MAGNIFIER over the object. (Excluding product number 1870)



1845-BK  
 Black metallic finish

No.1845-BK **3×** 65 mm (2 1/2")

No.1845-G **3×** 65 mm (2 1/2")

● inner box : 10pcs



No.1800 **5×** 40 mm (1 5/8")

● inner box : 10pcs  
 ● Gold finish  
 ● Gift box made from Paulownia wood



No.1880 **5×** 60 mm (2 3/8")

● inner box : 10pcs  
 ● Supplied in a presentation gift box



No.1870 **3×** 65 mm (2 1/2")

● inner box : 10pcs  
 ● Gold finish  
 ● Supplied in a presentation gift box



No.1890 **4×** 80 mm (3 1/8")

● inner box : 10pcs

**BAR MAGNIFIER** The permanent red guideline is convenient for reading a dictionary

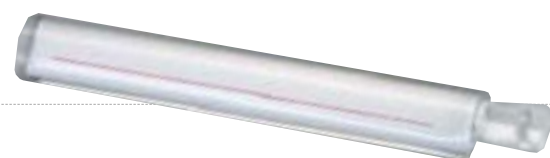

No.750 **2×** 25×150 mm (1"×6")

● inner box : 12pcs  
 ● With Pouch

**TWEEZER MAGNIFIER**



ST-30 **7×** 12 mm (1/2")  
 ● inner box : 20pcs



No.1950 **6×** 30 mm (1 1/4")  
 ● inner box : 10pcs  
 ● With Case



No.1970 **4×** 12 mm (1/2")  
 ● inner box : 10pcs  
 ● With Case



No.1960 **4.5×** 30 mm (1 1/4")  
 ● inner box : 10pcs  
 ● With fine tweezers  
 ● With Case

GL : glass lens type    WL : white lens type    PL : plastic lens type    Hook : A strap is available for suspending.

To order the hanging type, add an F in the end of the product number when ordering.

BINOCULAR MAGNIFIER

BINOCULAR MAGNIFIER

- This headset type magnifier allows you to use the both hands for complicated work.
- The velcro fastener allows you to adjust the length of head belt.
- Optional lenses of different magnifications are available. By changing lenses, you can use this magnifier with your desired magnifications and purposes.
- You don't have to take off your eyeglasses, when using this magnifier.

- The padded headband is easy and comfortable to use.

MAGNIFICATION	1.8×	2.3×	2.7×	3.5×
Work Distance	16~30cm	11~20cm	9~15cm	7~11cm
When using an additional lens	12~14cm	11~13cm	10~12cm	9~11cm

※ The work distance gap depends on the person using the product.



With Inner Lens

No. BM-110 **1.8× & 3.3×**

- Flipping the inside lenses up provides 3.3 magnification.
- inner lens : Hard coating Plastic lens.



- No. BM-120A **1.8×**
- No. BM-120B **2.3×**
- No. BM-120C **2.7×**
- No. BM-120D **3.5×**

WL



With Attachable Lens

With Attachable Lens

- No. BM-120AE **1.8× & 4.8×** (When using an additional lens)
- No. BM-120BE **2.3× & 5.3×** (When using an additional lens)
- No. BM-120CE **2.7× & 5.7×** (When using an additional lens)
- No. BM-120DE **3.5× & 6.5×** (When using an additional lens)

WL



No. BM-115W **2.3× & 3.3×**

- Flipping the inside lenses up provides 3.3 magnification.
- inner lens : Hard coating Plastic lens.



With Inner Lens



With Light

- This product with a lighting system is very effective in situations where normal light is limited at the site.
- The light emission diode (LED) used in this product provides bright clear light coupled with long working life.

With Light

- No. BM-120LA **1.8×**
- No. BM-120LB **2.3×**
- No. BM-120LC **2.7×**
- No. BM-120LD **3.5×**

WL

[Light source] Light Emission Diode (LED)  
 [Power supply] 2-CR2016 Lithium batteries  
 [Continuous lighting duration] Up to 16 hours



HEAD BAND SIZE ADJUSTING KNOB



- No. BM-100A **1.8×**
- No. BM-100B **2.3×**
- No. BM-100C **2.7×**
- No. BM-100D **3.5×**

WL

INTERCHANGEABLE LENS

By removing the screws you can replace the lenses.



Applicable for BM-100 only

- No. BM-100A1 **1.8×**
- No. BM-100B1 **2.3×**
- No. BM-100C1 **2.7×**
- No. BM-100D1 **3.5×**
- inner box : 10pcs

WL

INTERCHANGEABLE LENS

Easy lens replacement

Replacement lenses are only applicable for BM-120, BM-120E and BM-120L.



- No. BM-120A1 **1.8×**
- No. BM-120B1 **2.3×**
- No. BM-120C1 **2.7×**
- No. BM-120D1 **3.5×**
- inner box : 10pcs

WL

GL : glass lens type    WL : white lens type    PL : plastic lens type    Hook : A strap is available for suspending.

To order the hanging type, add an F in the end of the product number when ordering.

SPECTACLE MAGNIFIER · LOUPE GLASS

LINEN TESTER

SPECTACLE MAGNIFIER

The BINOCULAR MAGNIFIER allows you to use both hands

※This photograph was taken to show the type of application, this actual product is not for sale.



**Clip Type with Spectacles**  
Easy to fit on Spectacles Frame

No.HF-20A **2×**

No.HF-20B **2.5×**

No.HF-20C **3×**

- inner box : 10pcs
- Hard coating Plastic lens
- Clip-on type, With Case

MAGNIFICATION	2×	2.5×	3×
Work Distance	17~30cm	15~25cm	12~19cm

※ The work distance gap depends on the person using the product.

The SPECTACLE MAGNIFIER is easy to use, convenient with high-efficiency magnification to provide the feeling of wearing glasses. This enables you to look with both eyes. Typical examples are when reading small characters in a dictionary, DIY work, favorite pursuits or fishing. For business use, we guarantee the efficiency to meet your expectations in printing processes or precision machine work such as a watch making. This product is highly regarded by the medical service. Please give it a try we are sure you can appreciate its efficiency and convenience.



For those who do not wear glasses

**Spectacles Type**

No.HF-10A **2×**

No.HF-10B **2.5×**

No.HF-10C **3×**

- inner box : 10pcs
- Hard coating Plastic lens
- With Case

INTERCHANGEABLE LENS



No.HF-A1 **2×**

No.HF-B1 **2.5×**

No.HF-C1 **3×**

- inner box : 10pcs
- Hard coating Plastic lens

BOX SET



No.HF-20ABC **2×&2.5×&3×**

- inner box : 10pcs
- With 3 Lens
- Hard coating Plastic lens



No.HF-10ABC **2×&2.5×&3×**

- inner box : 10pcs
- With 3 Lens
- Hard coating Plastic lens



No.HF-20BF **2.5×**

- inner box : 10pcs
- Without Case
- Hard coating Plastic lens



No.HF-10BF **2.5×**

- inner box : 10pcs
- Without Case
- Hard coating Plastic lens

HANGING TYPE

LOUPE GLASS

- Compact and space-saving.
- You can use it together with your glasses.
- You can use it as a substitute for glasses.
- Hardening-Coated Lens(LG-10A Only)



No.LG-10A **3Diopter**

- inner box : 10pcs
- Small-sized lens
- 5× magnification
- Supplied in a cloth case
- Hard coating Plastic lens

No.LG-10B **3Diopter**

- inner box : 10pcs
- Without the small-size lens
- Supplied in a vinyl case
- Supplied without hard coated lens

No.LG-10AD  
●12pcs

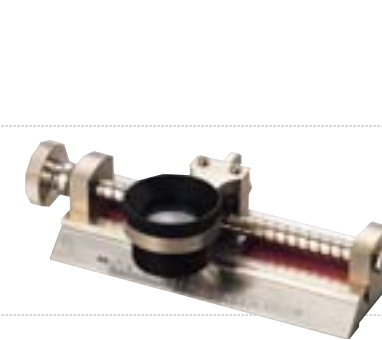

No.7680 **10×** 25 mm & 1" scale

- inner box : 12pcs
- Double Lens



No.7660

No.7670

No.7660 **5×** 30 mm & 1 1/2" scale

No.7670 **4×** 50 mm & 2" scale

- inner box : 12pcs
- Double Lens

**Difference between single and double lens type**

In comparison with single lens type, the distortion variability around the lens is less in the double lens type. When your eye is close to the lens the variability is small. However, as the distance increases between the lens and your eyes, the variability increases.



No.7520

No.7530



No.7550

No.7520 **9×** 10 mm & 1/2" scale

No.7530 **7×** 15 mm & 3/4" scale

No.7550 **6×** 25 mm & 1" scale

- inner box : 12pcs
- Single Lens

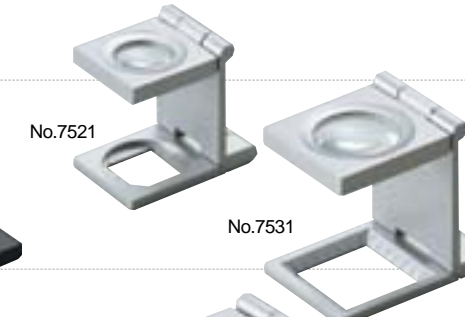

No.7521

No.7531



No.7551

No.7521 **9×** 10 mm & 1/2" scale

No.7531 **7×** 15 mm & 3/4" scale

No.7551 **6×** 25 mm & 1" scale

- inner box : 12pcs
- Single Lens



No.7522

No.7532



No.7552

No.7522 **9×** 10 mm & 1/2" scale

No.7532 **7×** 15 mm & 3/4" scale

No.7552 **6×** 25 mm & 1" scale

- inner box : 12pcs
- Double Lens



No.7650-M **6×** 25 mm scale

No.7650-I **6×** 1" scale

- inner box : 12pcs
- Single Lens
- With Needle



No.7651-M **6×** 25 mm scale

No.7651-I **6×** 1" scale

- inner box : 12pcs
- Single Lens
- With Needle

GL : glass lens type    WL : white lens type    PL : plastic lens type    Hook : A strap is available for suspending.

To order the hanging type, add an F in the end of the product number when ordering.

## SCALE LOUPE · POCKET MICROSCOPE

## METAL HOLDERS LOUPE

### SCALE LOUPE



**No.SL-10 10×** 28 m/m (1 1/8")  
●inner box : 12pcs 

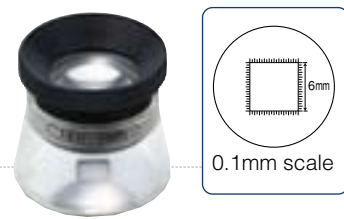

**No.SL-15 15×** 20 m/m (3/4")  
●inner box : 12pcs 

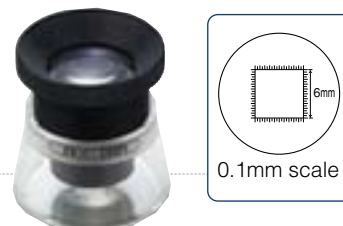

**No.SL-22 22×** 15 m/m (5/8")  
●inner box : 12pcs



**No.SL-7A 7×** 22 m/m (7/8")  
●inner box : 12pcs  
●Acromatic Lens  
●With Case



**No.SL-10A 10×** 28 m/m (1 1/8")  
●inner box : 12pcs  
●Acromatic Lens  
●With Case



**No.SL-15A 15×** 20 m/m (3/4")  
●inner box : 12pcs  
●Acromatic Lens  
●With Case

### POCKET MICROSCOPE



**No.PS-30 Telescope 8× & Microscope 30×**  
●inner box : 20pcs  
●To use the microscope, when viewed, the image is inverted.



**No.MK-31 30×**  
●inner box : 12pcs  
●When viewed, the image is inverted.



**No.PS-15 3× & 15×**  
●inner box : 20pcs  
●With Case

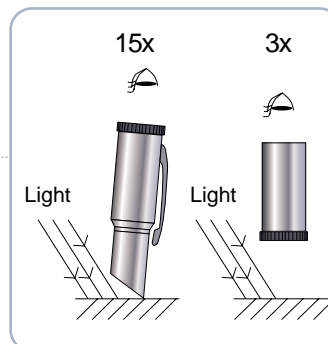

To adjust focus, tilt the microscope.

**No.MK-22 20×**  
**No.MK-32 30×**  
**No.MK-52 50×**  
●inner box : 10pcs  
●When viewed, the image is inverted.



**No.RX-15S 15×**  
●inner box : 20pcs 



**No.MS-20 20×**  
**No.MS-30 30×**  
**No.MS-50 50×**  
●inner box : 10pcs  
●When viewed, the image is inverted.

### METAL HOLDERS LOUPE



Used for high- power magnification such as in jewelry appraisal, the printing industry or drafting



**No.7015 10×** 20.5 m/m (3/4")  
●inner box : 12pcs  
●Triplet Lens  
●With Case

**No.7030 10×** 28 m/m (1 1/8")  
**No.7035 15×** 20 m/m (3/4")  
●inner box : 12pcs

**No.7036 10×** 20.5 m/m (3/4")  
●inner box : 12pcs  
●Triplet Lens

**No.HL-10 10×** 28 m/m (1 1/8")   
**No.HL-15 15×** 20 m/m (3/4")   
●inner box : 12pcs



**No.7025 16×** 13 m/m (1/2")  
**No.7055 12×** 20 m/m (3/4")  
●inner box : 12pcs  
●With Case

**No.7010 10×** 17 m/m (11/16")  
**No.7011 18×** 17 m/m (11/16")  
●inner box : 12pcs  
●With Case

**No.7012 10×** 17 m/m (11/16")  
**No.7013 18×** 17 m/m (11/16")  
●inner box : 12pcs  
●Lightweight type

**No.7010 : Triplet Lens**  
**No.7011 : Five Lens**  
**No.7012 : Triplet Lens**  
**No.7013 : Five Lens**







**No.7080 10×** 15 m/m (5/8")  
**No.7090 20×** 15 m/m (5/8")  
●inner box : 12pcs  
●Acromatic Lens  
●With Leather Case

**No.7071 3× & 5×** 20 m/m (3/4")  
●inner box : 12pcs  
●With Case  
●Using 2 lenses together provides 7× magnification.

**No.7070 3× & 4× & 5×** 20 m/m (3/4")  
●inner box : 12pcs  
●With Case  
●Using 3 lenses together provides 10× magnification.



**No.7020 10×** 13 m/m (1/2")  
**No.7050 10×** 20 m/m (3/4")   
**No.7060 8×** 25 m/m (1") 

**No.7020-W 10×** 13 m/m (1/2") & **20×** 8 m/m (5/16")   
**No.7050-W 8×** 25 m/m (1") & **15×** 13 m/m (1/2") 

●inner box : 12pcs  
●With Case 

#### Acromatic Lens

The way the light refracts through a lens varies, depending on the light wavelength. The light passing through a lens disperses to the 7-color spectrum like a rainbow so does not converge. Each color has own focal point. The Acromatic lens is made by bonding lenses with different refraction indexes to adjust the different color focal points so they converge.

#### Triplet Lens

The concept is the same as the Acromatic lens. To correct the focal points more efficiently, 3 lenses are bonded together. For jewelry appraisal, this lens is highly recommended.

 : glass lens type  : white lens type  : plastic lens type  : A strap is available for suspending.

To order the hanging type, add an F in the end of the product number when ordering.



METAL HOLDERS LOUPE · PLASTIC HOLDERS LOUPE · WATCH MAKER'S LOUPE

You can use this type for whatever you want. The chain length is 76cm for the whole range. **PENDANT MAGNIFIER**

**METAL HOLDERS LOUPE** 4× Lens...Using 2 lenses together provides 7× magnification.



- No.7850 4× 30 mm (1 1/4") ●inner box : 12pcs GL Hook
- No.7860 4×&4× 30 mm (1 1/4") ●inner box : 12pcs GL Hook
- No.7950 4× 36 mm (1 1/2") ●inner box : 12pcs GL Hook
- No.7960 4×&4× 36 mm (1 1/2") ●inner box : 12pcs GL Hook



- No.353-G No.353-S
- No.354-G No.354-S
- No.327-G No.327-S
- No.353-G 4× 35 mm (1 3/8") ●inner box : 10pcs WL
- No.353-S 4× 35 mm (1 3/8") ●inner box : 10pcs WL
- No.354-G 3.5× 40×30 mm (1 5/8"×1 1/4") ●inner box : 10pcs WL
- No.354-S 3.5× 40×30 mm (1 5/8"×1 1/4") ●inner box : 10pcs WL
- No.327-G 3.5× 35×25 mm (1 3/8"×1") ●inner box : 10pcs WL
- No.327-S 3.5× 35×25 mm (1 3/8"×1") ●inner box : 10pcs WL

**PLASTIC HOLDERS LOUPE** 4× Lens...Using 2 lenses together provides 7× magnification, using 3 lenses together provides 10× magnification.



No.7910 No.7920 No.7930

- No.7910 4× 36 mm (1 1/2") ●inner box : 12pcs GL
- No.7920 4×&4× 36 mm (1 1/2") ●inner box : 12pcs GL
- No.7930 4×&4×&4× 36 mm (1 1/2") ●inner box : 12pcs GL



No.7810 No.7820 No.7830

- No.7810 4× 30 mm (1 1/4") ●inner box : 12pcs GL
- No.7820 4×&4× 30 mm (1 1/4") ●inner box : 12pcs GL
- No.7830 4×&4×&4× 30 mm (1 1/4") ●inner box : 12pcs GL



No.7710 No.7720 No.7730

- No.7710 4× 24 mm (1") ●inner box : 12pcs GL
- No.7720 4×&4× 24 mm (1") ●inner box : 12pcs GL
- No.7730 4×&4×&4× 24 mm (1") ●inner box : 12pcs GL

**WATCH MAKER'S LOUPE**

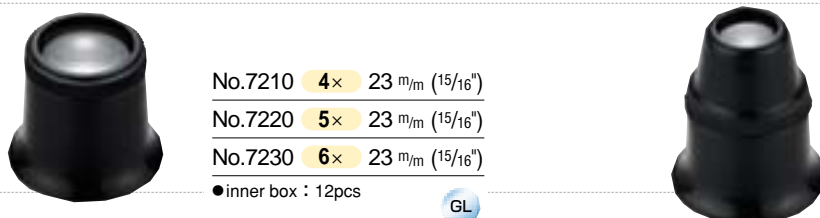

- No.7210 4× 23 mm (15/16") ●inner box : 12pcs GL
- No.7220 5× 23 mm (15/16") ●inner box : 12pcs GL
- No.7230 6× 23 mm (15/16") ●inner box : 12pcs GL
- No.7300 10× 15 mm (5/8") ●inner box : 12pcs GL ●Double Lens



- No.323-G No.323-S
- No.324-G No.324-S
- No.326-G No.326-S
- No.323-G 4× 35 mm (1 3/8") ●inner box : 10pcs WL
- No.323-S 4× 35 mm (1 3/8") ●inner box : 10pcs WL
- No.324-G 3.5× 40×30 mm (1 5/8"×1 1/4") ●inner box : 10pcs WL
- No.324-S 3.5× 40×30 mm (1 5/8"×1 1/4") ●inner box : 10pcs WL
- No.326-G 3.5 Diopter 35×25 mm (1 3/8"×1") Hold close to your eye for viewing. ●inner box : 10pcs WL
- No.326-S 3.5 Diopter 35×25 mm (1 3/8"×1") ●inner box : 10pcs WL



- No.328-G No.328-S
- No.325-G No.325-S
- No.329-G No.329-S
- No.328-G 3.5× 40×30 mm (1 5/8"×1 1/4") ●inner box : 12pcs ●Engraved on both faces, Coating Lens WL
- No.328-S 3.5× 40×30 mm (1 5/8"×1 1/4") ●inner box : 12pcs ●Engraved on both faces, Coating Lens WL
- No.325-G 3.5× 40×30 mm (1 5/8"×1 1/4") ●inner box : 12pcs ●Engraved on both faces, Coating Lens WL
- No.325-S 3.5× 40×30 mm (1 5/8"×1 1/4") ●inner box : 12pcs ●Engraved on both faces, Coating Lens WL
- No.329-G 3× 27×35 mm (1 1/8"×1 3/8") ●inner box : 12pcs ●Engraved on both faces, Coating Lens WL
- No.329-S 3× 27×35 mm (1 1/8"×1 3/8") ●inner box : 12pcs ●Engraved on both faces, Coating Lens WL

GL : glass lens type WL : white lens type PL : plastic lens type Hook : A strap is available for suspending.

To order the hanging type, add an F in the end of the product number when ordering.

FLESNEL STAND MAGNIFIER

WIDE VIEW STAND MAGNIFIER

You can enjoy an extensive field of vision for Reading ;  
in viewing Map,Telephone-Directory,Drawing,etc. . . .



No.1790 **1.7x** 215×260 mm (8 1/2"×10 1/4")  
 ● With Lens Cover  
 ● Flesnel lens



The flexible neck provides easy control and position.

No.1730 **1.8x** 140×193 mm (5 1/2"×7 5/8")  
 [Neck length h : 23cm (9")]  
 ● Flesnel lens



- User-friendly stand magnifier for reading or precision work
- Supplied with 4X and 7X high-power lenses
- 110 × 145 mm super-jumbo lens provides extensive vision field to work efficiently over a broad area, without moving the lens. (Hard coated plastic lens)
- Convenient for storage or carrying.



Shown when folded

No.1795 **1.8x** 110×145 mm (4 3/8"×5 3/4")  
 Additional viewing lenses : **4x** 30 mm (1 1/4")  
**7x** 25 mm (1")

- Hard Coating Plastic Lens
- With Lens Cover



For reading a book or newspaper, place the WIDE VIEW STAND MAGNIFIER as shown in application A. The lens close to your eyes provides an extensive field of vision. When using both your hands to work, place the WIDE VIEW STAND MAGNIFIER as shown as in application B. The arms of the magnifier will not be in your way.

GL : glass lens type

WL : white lens type

PL : plastic lens type

Hook : A strap is available for suspending .

To order the hanging type, add an F in the end of the product number when ordering.

**STAND MAGNIFIER** Hand free fixing type, suitable for precision work or for inspection work in a factory

**GOOSE NECK MAGNIFIER · NECK MAGNIFIER**

When you want to focus on especially small objects, you can see them with the extra lens situated in the bottom lens. Since the lens has a hard coating, the lens is not easily damaged.



**No.1770DL 1.8x & 3.5x (Bifocal Lens)**  
110x145 mm (4 3/8" x 5 3/4")  
● Hard Coating Plastic Lens

**No.1770 1.8x & 3.5x (Bifocal Lens)**  
110x145 mm (4 3/8" x 5 3/4")  
● Hard Coating Plastic Lens

**No.1780 1.8x 130 mm (5")**

**No.1751 2x 100 mm (4")**  
**No.1761 1.8x 115 mm (4 1/2")**

## SMALL STAND MAGNIFIER



**No.1600 3.5x 45 mm (1 3/4")**  
● inner box : 6pcs

**No.1610 3.5x 50 mm (2")**

**No.1620 3x 65 mm (2 1/2")**

**No.1630 2.5x 75 mm (3")**



**No.1645 4x & 4x**  
36 mm (1 1/2")  
● Using 2 lenses together provides 7x magnification.

**No.1650 2.5x**  
90 mm (3 1/2")

The distance for best viewing results is 6 to 7cm from the object to the lens.

**No.1655AS 3.5x 90 mm (3 1/2")**  
● Hard Coating Plastic Lens



With LED Light

**No.1703L 3.5x**  
40x50 mm (1 5/8" x 2")  
● inner box : 10pcs  
● Supplied with 3- LR44 batteries  
● Fresnel lens



**No.1701 4.5x 30 mm (1 1/4")**  
● inner box : 20pcs



**No.1720PC 2x & 4x (Bifocal Lens)**  
100 mm (4")  
● inner box : 5pcs  
● Color : ivory · black  
[Neck length h : 23cm (9")]  
● Hard Coating Plastic Lens



**No.1705L**  
**2x 78x150 mm (3" x 6")**  
**3x 55x89 mm (2 1/8" x 3 1/2")**  
● inner box : 10pcs  
● Supplied with 3- LR44 batteries  
● Acrylic lens · With Case



**No.1720PS 2x & 4x (Bifocal Lens)**  
100 mm (4")  
● inner box : 5pcs  
● Color : ivory · black  
[Neck length h : 23cm (9")]  
● Hard Coating Plastic Lens



## NECK MAGNIFIER

Suitable for embroidery or knitting



**No.6500 2x 100 mm (4")**  
● inner box : 12pcs

**No.6500-P 2x & 4x (Bifocal Lens) 100 mm (4")**  
● inner box : 12pcs  
● Bifocal lens  
● Hard Coating Plastic Lens

**No.6550 2x 100 mm (4")**  
● inner box : 12pcs  
● Three different applications are available.

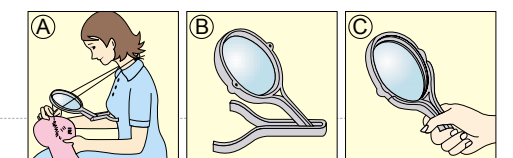

GL : glass lens type    WL : white lens type    PL : plastic lens type    Hook : A strap is available for suspending

To order the hanging type, add an F in the end of the product number when ordering.

## GALLERY SCOPE · MICROSCOPE

### GALLERY SCOPE

This telescope provides 20 cm to infinity observation. For use in museum or art location. This telescope is useful for users with amblyopic eyesight problems.



No.KM-412 **4x**  
 ● Fully multi coated optics  
 ● With Case

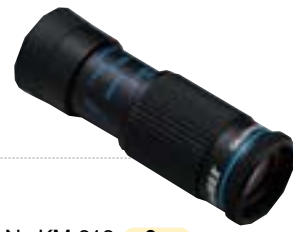

No.KM-616 **6x**  
 ● Fully multi coated optics  
 ● With Case



No.KM-820 **8x**  
 ● Fully multi coated optics  
 ● With Case

Model	KM-412	KM-616	KM-820
Specification	4×12	6×16	8×20
Magnification	Infinity	4×	6×
	Minimum distance	5.5×	7.6×
Field of view at 100 m	22m	16m	12m
Shortest focus	20cm	23cm	30cm
Size	31×58mm	31×72mm	34×98mm
Weight(Net)	55g	65g	112g
Magnification with stand	12×	20×	25×

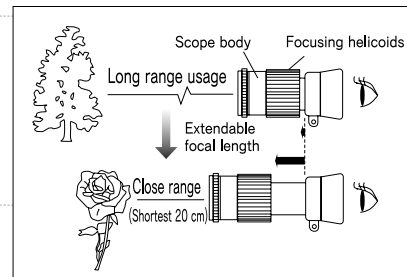

### MONOCLE & MICRO STAND WITH LIGHTING SYSTEM — Upright type enables observation in the same direction as sight vision.

The MICRO STAND integrates the MONOCLE to enables close range observation. This product can be used as a microscope with 12 to 25× magnification.



No.KM-412LS **12x**  
 ● With Case



No.KM-616LS **20x**  
 ● With Case



No.KM-820LS **25x**  
 ● With Case

#### Features of the MICRO STAND WITH LIGHTING SYSTEM KM-412LS, KM-616LS and KM-820LS

An innovative lighting feature using a LED has been installed in the micro stand. This adds additional brightness in areas where natural light is low. The micro stand and lighting system allows you to observe in a clear bright environment.

- [Light source] Light Emission Diode (LED)
- [Power supply] 2-CR2016 Lithium batteries
- [Continuous lighting duration] Up to 16 hours



▲ Enlarged graphic image



### HAND TELESCOPE



No.TS-817 **8x** 17 m/m (1 1/16")  
 ● inner box : 10pcs



No.TS-11 **10x** 30 m/m (1 1/4")  
 ● inner box : 10pcs



No.TS-31 **25x** 30 m/m (1 1/4")  
 ● inner box : 10pcs

### SPORT GLASSES



No.BX-10 **3x** 28 m/m (1 1/8")  
 ● inner box : 10pcs  
 ● SIZE : 65×115×19mm  
 ● Weight : 64g  
 ● Color : blue

### PORTABLE LOUPE



No.KL-10 **3x** 38 m/m (1 1/2")  
 ● inner box : 20pcs  
 PL Hook



No.KL-20 **2x** 35×25×12 m/m (1 3/8"×1"×1/2")  
 ● inner box : 20pcs  
 PL Hook

GL : glass lens type    WL : white lens type    PL : plastic lens type    Hook : A strap is available for suspending.

To order the hanging type, add an F in the end of the product number when ordering.